

Article number: 439500340

Description: Rota-fix shaft-hub connection F340x425
Steel

Note: Self centering. Very high torque

Measures

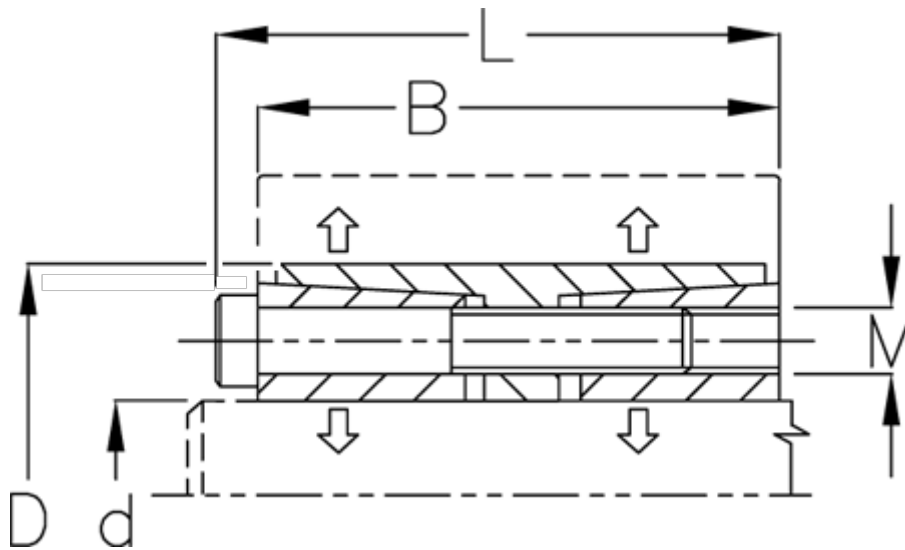

B mm	= 177
d H8 mm	= 340
D mm	= 425
Fit tolerance	= Aksel h8, Nav H8
F kN torque	= 2740.0
L mm	= 197
M mm	= M20
P N/mm ² surface pressure on shaft/hub	= 104

Surface roughness	= R? ? 3.2 µm
T N m torque	= 465000
Ts N m bolt tightening torque	= 690.0